



Wet-Dry Dual Stage EFI Nitrous System 4&6 8 CYL System

CONGRATULATIONS on purchasing your DynoTune Nitrous Oxide Injection System! Your system is composed of the highest quality components available. It should provide many miles of trouble-free performance when used correctly. If you have any questions regarding the performance of our system, call DynoTune Technical Service at (978) 562-6040.

NOTICE: Installation of this DynoTune INC. Nitrous oxide system product signifies that you have read this document and have agreed to the terms stated within.

It is the purchaser's responsibility to follow all installation instruction guidelines and safety procedures supplied with the product as it is received by the purchaser to determine the compatibility of the product with the vehicle or the device the purchaser intends to install the product on.

DynoTune assumes no responsibility for damages occurring from accident, misuse, abuse, improper installation, improper operation, lack of reasonable care, or all previously stated reasons resulting from incompatibility with other manufacturers' products.

DynoTune neither recommends nor condones the use of products manufactured or sold by DynoTune on vehicles, which may be driven on public roads or highways, and assumes no responsibility for damages incurred by such use.

DynoTune nitrous oxide is legal for use in most states when used in accordance with state and local traffic laws. DynoTune does not recommend or condone the use of its products in illegal racing activities.

DynoTune has not pursued California Air Research Board (CARB) exemptions for these kits, hence, they are not legal for use on pollution-controlled vehicles in California. A correctly installed DynoTune nitrous system should not alter the emission control performance of your vehicle under standard EPA test cycle conditions.

NOTICE: DynoTune Nitrous Systems are not intended for use on hatchback type vehicles without the use of a DynoTune bottle blow-down tube kit.

HAZARDS DEFINED

This manual presents step-by-step instructions that describe the process of installing your DynoTune Nitrous Oxide Injection System. These procedures provide a framework for installation and operation of this kit. Parts are referenced by name and number to avoid confusion. Within the instructions, you are advised of potential hazards, pitfalls, and problems to avoid. The following examples explain the various hazard levels:

WARNING! Failure to comply with instructions may result in injury or death

CAUTION! Failure to comply with instructions may result in damage to equipment.

NOTE: This information is important, needs to be emphasized, and is set apart from the rest of the text.

HINT: These special instructions provide a handy work tip.

NITROUS OXIDE INJECTION SYSTEM SAFETY TIPS

WARNINGS

- ❑ Do not attempt to start the engine if the nitrous has been injected while the engine was not running. Disconnect the coil wire and turn the engine over with the throttle wide open for several revolutions before attempting to start. Failure to do so can result in extreme engine damage.
- ❑ Never permit oil, grease, or any other readily combustible substances to come in contact with cylinders, valves, solenoids, hoses, and fittings. Oil and certain gases (such as oxygen and nitrous oxide) may combine to produce a highly flammable condition.
- ❑ Never interchange nitrous and fuel solenoids. Failure to follow these simple instructions can result in extreme engine damage and/or personal injury.
- ❑ Never drop or violently strike the bottle. Doing so may result in an explosive bottle failure.
- ❑ Never change pressure settings of safety relief valve on the nitrous bottle valve. Increasing the safety relief valve pressure settings may create an explosive bottle hazard.
- ❑ Identify the gas content by the Dynotune on the bottle before using. If the bottle is not identified to show the gas contained, return the bottle to the supplier.
- ❑ Do not deface or remove any markings, which are on the nitrous bottle.
- ❑ Nitrous bottle valves should always be closed when the system is not being used.
- ❑ Notify the supplier of any condition, which might have permitted any foreign matter to enter the valve or bottle.
- ❑ Keep the valves closed on all empty bottles to prevent accidental contamination.
- ❑ After storage, open the nitrous bottle valve for an instant to clear the opening of any possible dust or dirt.
- ❑ It is important that all threads on the valves and solenoids are properly mated. Never force connections that do not fit properly.

TABLE OF CONTENTS

WHAT IS NITROUX OXIDE?

Do's and Don'ts of Nitrous Oxide

Chapter 1. Introduction to your DynoTune Nitrous Oxide Kit

- 1.1 General Information
- 1.2 System Requirements
- 1.3 Kit Components

Chapter 2. Kit Installation

- 2.1 Bottle Mounting Instructions
 - 2.1.1 Street Vehicles
 - 2.1.2 Racing Vehicles
- 2.2 Bottle Orientation
- 2.3 Bottle Installation
- 2.4 Wet/Dry Nozzle Installation
- 2.5 Solenoid Mounting
- 2.6 Solenoid/Wet/Dry Nozzle Hose Connection
- 2.7 Nitrous Feed Line Mounting
- 2.8 Fuel Supply Connection
 - 2.8.1 Fuel Supply Connection by using Fuel Rail Test Port
 - 2.8.2 Fuel Supply Connection by Tapping Fuel Rail
 - 2.8.3 Fuel Supply Connection by Tapping into Main Fuel Supply Fitting
 - 2.8.4 Fuel Supply Connection by Tapping into Main Fuel Supply Hose (Rubber Hose Only)
- 2.9 Electrical System Installation / Window Switch installation

Chapter 3. Baseline Tuning Suggestions

Chapter 4. Preparing for Operation

Chapter 5. Advanced Tuning for Maximum Power

- 5.1 Determining Optimum Nitrous/Fuel Jetting
- 5.2 Determining Optimum Ignition Timing

Chapter 6. Routine Maintenance

- 6.1 Nitrous Solenoid Filter
- 6.2 Nitrous Solenoid Plunger
 - 6.2.1 General Information
 - 6.2.2 Nitrous Solenoid Plunger Disassembly and Inspection

Appendix A. Troubleshooting Guide

WHAT IS NITROUS OXIDE?

Nitrous Oxide ...

- ... Is a cryogenic gas composed of nitrogen and oxygen molecules.
- ... Is 36% oxygen by weight.
- ... Is non-flammable by itself
- ... Is stored as a compressed liquid
- ... Exists in two grades --- U.S.P. and Nitrous Plus:

- ❑ U.S.P. is medical grade nitrous oxide; its common use is dental and veterinary anesthesia. It is commonly used as a propellant in canned whipped cream. U.S.P. is not available to the public.
- ❑ Nitrous Plus differs from U.S.P. in that it contains trace amounts of sulphur dioxide added to prevent substance abuse. Nitrous Plus is intended for automotive applications and is available for sale to the public.

In automotive applications, Nitrous Plus and fuel are injected into the engine's intake manifold, which produces the following results:

- ❑ Lowers engine intake air temperature, producing a dense inlet charge.
- ❑ Increases the oxygen content of the inlet charge (air is only 22 percent oxygen by weight).
- ❑ Increase the rate at which combustion occurs in the engine's cylinders.

Do's and Don'ts of Nitrous Oxide

Do's

- ❑ Read all instructions before attempting to install your DynoTune nitrous system.
- ❑ Make sure your fuel delivery system is adequate for the nitrous jetting you have chosen. Inadequate fuel pressure or flow will result in engine damage.
- ❑ Use 14-gauge (minimum) wire when installing electrical system components.
- ❑ Use high-quality connections at all electrical joints.
- ❑ Use Teflon-based paste on pipe-style fittings.
- ❑ Make sure your engine and related components (ignition, carburetor, and driveline) are in proper working condition. *Do not use any performance chip or modified computer that advances timing more than stock.*
- ❑ If nitrous is accidentally injected into the engine when it is not running, remove the engine coil wire, open the throttle, and crank the engine 10 to 15 seconds before starting. Failure to do so can result in an explosive engine failure.
- ❑ Use your DynoTune nitrous system only at wide-open throttle and at engine speeds above 3000 RPM.
- ❑ Install a proper engine to chassis ground. Failure to do so may result in an explosive failure of the main nitrous supply line.
- ❑ Use a high-quality fuel, as suggested in Chapter 3, Baseline Tuning Suggestions.

Don'ts

- ❑ Engage your nitrous system with the engine off. Severe engine damage can occur.
- ❑ Modify DynoTune nitrous systems (if you need a non-stock item, call DynoTune Technical Service for assistance).
- ❑ Over tighten AN type fittings.
- ❑ Use Teflon Tape on any pipe threads. Pieces of Teflon tape can break loose and become lodged in nitrous or fuel solenoids or solenoid filters. Debris lodged in a nitrous or fuel solenoid can cause catastrophic engine failure.

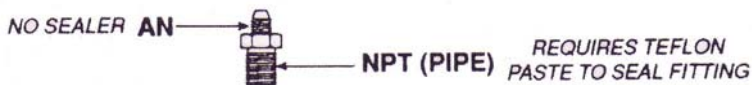

- ❑ Use sealant of any kind on AN type fittings.
- ❑ Allow nitrous pressure to exceed 1100 psi. Excessive pressure can cause swelling or in extreme cases failure of the nitrous solenoid plunger.
- ❑ Inhale nitrous oxide. Death due to suffocation can occur.
- ❑ Allow nitrous oxide to come in contact with skin. Severe frostbite can occur.
- ❑ Use octane boosters that contain methanol. Fuel solenoid failure may occur, producing severe engine damage.

Chapter 1. Introduction to your DynoTune Nitrous Oxide Kit

1.1 General Information

This kit is intended for 8 cylinder applications. This kit was designed to be used on late model multi-point fuel injection type engines with 43 psi \pm 5 psi fuel pressure and A MAF (Mass air flow sensor).

NOTE: This nitrous oxide injection system injects a mixture of nitrous oxide and fuel into the air intake duct. If the instructions are not carefully followed, poor mixture distribution can occur, resulting in variations of air to fuel ratio from cylinder to cylinder. In extreme cases, intake manifold backfires can occur, if the instructions are not followed exactly. The Dry nitrous stage uses the cold nitrous to pass by the mass airflow sensor in the intake tract, cooling the sensor and fooling the computer into thinking a lot more air is going into the engine. The computer then adds extra fuel through the factory fuel injectors! This is where the extra power is made!

These kits have been designed for safety and smoothness of operation. Nitrous oxide is injected into the engine only when the following conditions are met:

- ❑ Bottle valve is opened, System Armed, Engine at wide-open Throttle.

Horsepower and torque increases due to these kits will vary with engine displacement and modifications. Approximate power increase estimates can be made based upon the massflow of nitrous oxide into the engine. The following table is provided to allow you to estimate the power increase you can expect for your application. DynoTune **strongly** suggests that an upper limit of about 40% to 50% increase in power output from your stock engine. Exceeding this can result in premature engine failure.

Table 1. 8 CYL Jetting Combinations @ 43 PSI Fuel Pressure

Cylinders	Nitrous / Fuel Jetting	Approximate Power Increase (BHP)
8 Cyl Wet Stage	42 / 24	75 HP
8 Cyl Wet Stage	48 / 28	100 HP
8 Cyl Wet Stage	57 / 32	150 HP
8 Cyl Dry Stage	24 / Not Used	25 HP
8 Cyl Dry Stage	28 / Not Used	35 HP
8 Cyl Dry Stage	32 / Not Used	50 HP
8 Cyl Dry Stage	42 / Not Used	75 HP
8 Cyl Dry Stage	48 / Not Used	100 HP
8 Cyl Dry Stage	57 / Not Used	150 HP

Table 1. 4/6 CYL Jetting Combinations @ 43 PSI Fuel

Cylinders	Nitrous / Fuel Jetting	Approximate Power Increase (BHP)
4/6 Cyl Wet Stage	28 / 16	35 HP
4/6 Cyl Wet Stage	34 / 18	50 HP
4/6 Cyl Wet Stage	42 / 24	75 HP
4/6 Cyl Dry Stage	24 / Not Used	25 HP
4/6 Cyl Dry Stage	28 / Not Used	35 HP
4/6 Cyl Dry Stage	32 / Not Used	50 HP
4/6 Cyl Dry Stage	42 / Not Used	75 HP
4/6 Cyl Dry Stage	48 / Not Used	100 HP
4/6 Cyl Dry Stage	57 / Not Used	150 HP

NOTE: If jets other than the ones recommended in the table are used, please refer to Chapter 3, "Baseline Tuning Suggestions" and Chapter 4, "Preparing for Operation", for additional information on jet selection. Drivability, fuel economy, and exhaust emissions should not be affected under normal (part throttle) conditions.

1.2 System Requirements

When used correctly, these kits should work with stock internal engine components. To ensure proper performance and engine life, the following is an absolute must: Limit Horse power to 150 unless proper fuel/Ignition/Driveline/Engine modifications are made.

❑ Manual Transmissions

If the vehicle is to be exposed to severe operating conditions, such as drag strip usage, the standard clutch should be replaced with a high performance unit.

❑ Automatic Transmissions

If the vehicle is to be exposed to severe operating conditions, such as drag strip usage, a reputable high-performance transmission shop should service the automatic transmission.

1.3 Kit Components

Before beginning the installation of your DynoTune nitrous kit, compare the components in your kit with those shown in Figure 1 and listed in Table 2. If any components are missing, please contact DynoTune Technical Support at (978) 562-6040.

Table 2. Wet-Dry Dual Stage Kit Parts List

Item	Description	Quantity	P/N
1	4AN Bottle Nut Adapter	1	
2	Bottle Nut Teflon Washer	1	
3	#10 N20 Bottle	1	
4	#10 Bottle Bracket Set	1	
5	Wet Nozzle	1	
5A	Dry Nozzle	1	
6	Wet/Dry Nozzle Adapter	2	
7	Wet/Dry Nozzle Adapter Nut	2	
8	Nitrous Solenoid	2	
9	Not In this kit	0	
10	2 ft. 3AN Hose (Blue)	2	
11	Fuel Solenoid	1	
12	4AN x 1/8"NPT X 1/8" NPT adaptor	1	
13	2 ft. 3AN Hose (Red)	1	
14	Solenoid Mounting Bracket w/screws Kit May contain Multiple single brackets	3	
15	Flare Jets	9	
16	16 ft. 4AN Hose (blue)	1	
17	Micro switch assembly (not used with TPS)	1	
18	Arming Switch	2	
19	Wiring Relay – 30 AMP	2	
20	Harness for Wiring Relay w/ Fuse	2	
21	2 ft. 4AN Hose (Red)	1	
22	1/16" NPT x 4AN Fitting	1	
23	5/16", 5/16", 5/16" Hose Barb Fitting	1	
24	5/16" Hose Clamp Fittings	3	
25	1/16" NPT Pipe Tap	1	
26	5/16" hose barb to 1/8" NPT	1	
27	3 feet rubber 5/16" fuel injection hose	1	

Figure 1. Two Stage Wet/Dry Kit Components

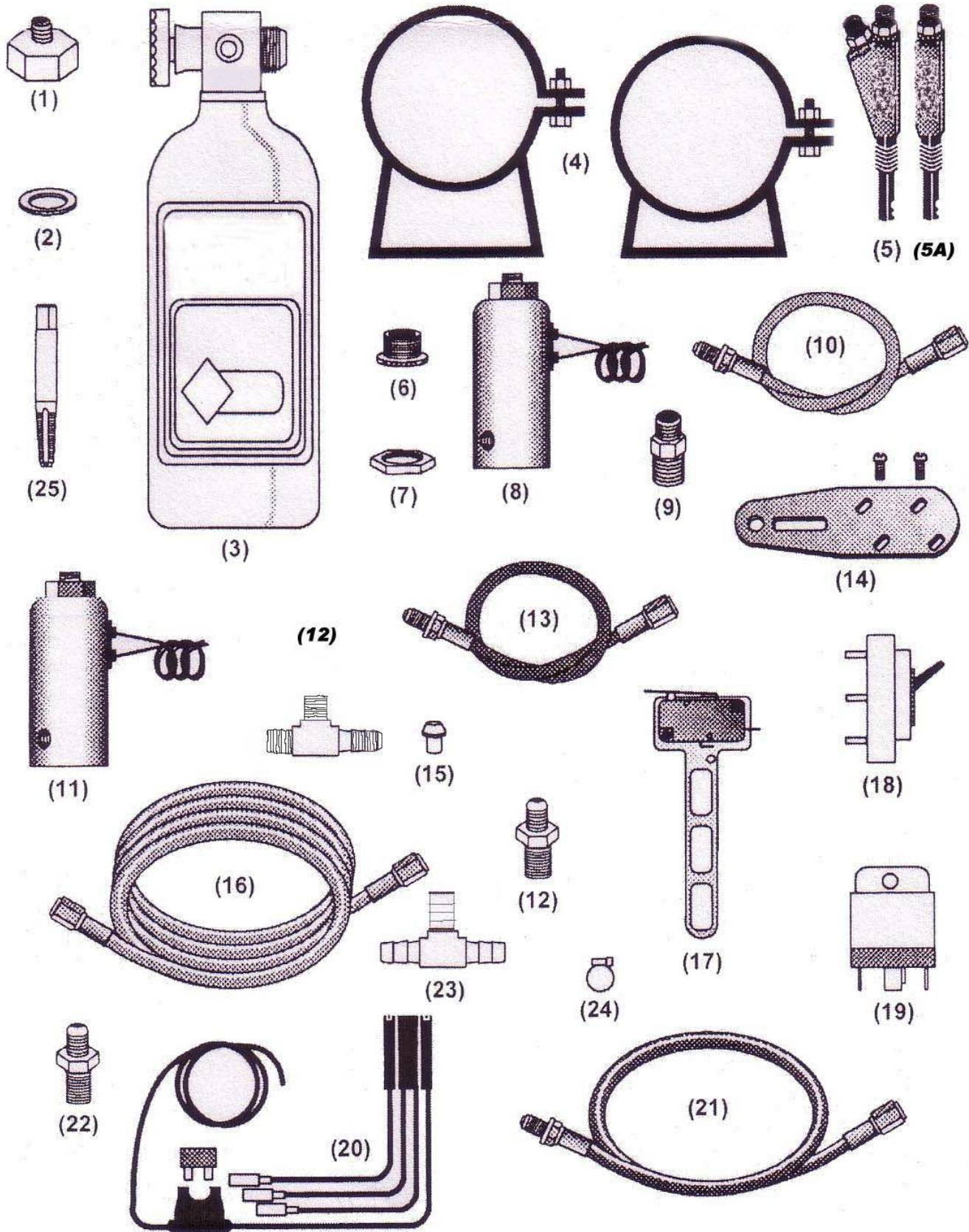

Chapter 2. Kit Installation

2.1 Bottle Mounting Instructions

NOTE: Disconnect the battery ground before beginning installation.

2.1.1 Street Vehicles

Accurate calibration of your DynoTune nitrous system depends on the bottle remaining at a stable temperature. Mount the bottle away from heat sources, such as the engine compartment or exhaust system, and away from windows, where the bottle is exposed to direct sunlight.

Dynotune recommends that the bottle be environmentally separated from the driver's compartment. Because hatchback-type vehicles generally do not have a firewall between the trunk area and the driver's compartment, the safety pressure relief cap should be replaced with a Blow-Down kit that will vent the Nitrous outside the passenger compartment during an over pressure condition. The blow-down tube should be routed to the exterior of the vehicle (preferably under the vehicle). This procedure will prevent filling the driver's compartment with a cloud of nitrous oxide, if the safety pressure relief cap should happen to rupture for any reason.

2.1.2 Racing Vehicles

Before mounting a nitrous bottle in a racing vehicle intended for use in sanctioned events, check with the sanctioning association for any rules regarding this subject. Most associations require that the bottle be mounted within the confines of the safety roll cage with the safety pressure relief cap vented away from the driver's compartment.

Figure 2 Nitrous Bottle Siphon Tube Orientation

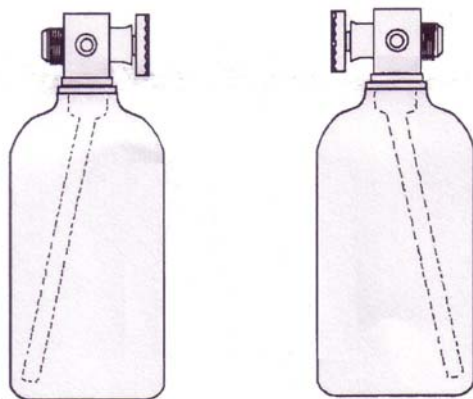
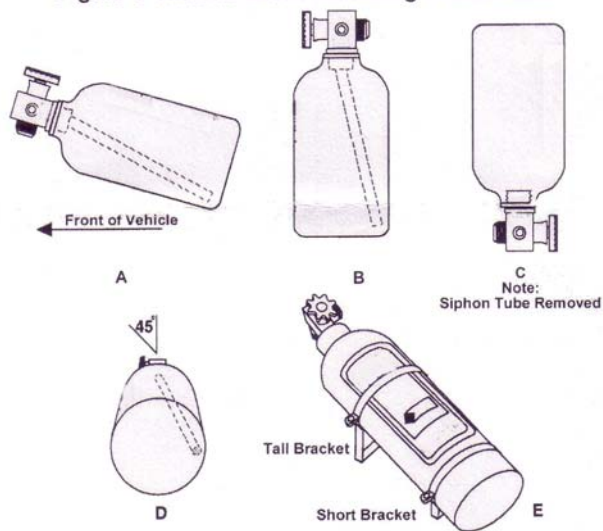

Figure 3 Nitrous Bottle Mounting Orientations



2.2 Bottle Orientation

Bottle placement is critical to the performance of your DynoTune nitrous system. It is important to understand how the bottle valve and siphon tube are assembled to properly orient the bottle in your vehicle and ensure that it picks up liquid nitrous while undergoing acceleration. All Dynotune nitrous bottles are assembled so that the bottom of the siphon tube is at the bottom of the bottle and opposite the bottle label (Figure 2).

Whenever the bottle is mounted in a lay-down position, the valve handle must be towards the front of the vehicle with the label facing up (Figure 3A).

If the bottle is mounted vertically, the label must face toward the front of the vehicle (Figure 3B). This orientation will position the siphon tube at the back of the bottle where the liquid N₂O will be during acceleration.

WARNING! DO NOT attempt to remove the siphon tube without completely emptying the bottle of all nitrous and pressure. Failure to completely empty the bottle will result in an explosive condition causing injury or death.

A bottle mounted upside-down must have the siphon tube removed before use (Figure 3C). Non-siphon bottles can be specially ordered from DynoTune.

If the bottle must be mounted parallel to the axles of the vehicle (sideways), the label must be angled at approximately 45° toward the front of the vehicle (Figure 3D). This orientation will position the siphon tube toward the rear of the bottle.

NOTE: When using a bottle with a siphon tube, the tall bracket should be at the valve end of the bottle and the short bracket at the bottom (Figure 3E).

The most efficient mounting is the lay-down position (Figure 3A) this position allows the greatest amount of liquid to be used before the siphon tube begins to pick up gaseous nitrous oxide.

2.3 Bottle Installation

After you have determined the location and orientation of the nitrous bottle, use the following procedure to install the bottle:

NOTE: Numbers in parentheses () refer to the parts list/assembly drawing number for the components. Figure 4 shows installation assembly for the DynoTune nitrous system.

- 1) Install the bottle nut adapter (1) and Teflon washer (2) on the nitrous bottle (3). Tighten securely.
- 2) Loosely install the bottle mounting brackets (4) on the nitrous bottle, as shown in fig 3E.
- 3) Locate the bottle/bracket assembly in the desired mounting location, ensuring that the location will provide easy access to the bottle valve, hose connection, and the bracket clamp bolts to facilitate bottle changing.
- 4) Use the assembled bottle/bracket unit as a pattern to mark and drill the four 5/16" holes in the mounting surface. **Caution: When Drilling or punching holes for the brackets, be aware of wires, hoses, fuel tanks etc that may be under or near the brackets!**
- 5) Mount the brackets securely to the surface.
Secure the bottle into the mounting brackets and tighten the bracket clamps.

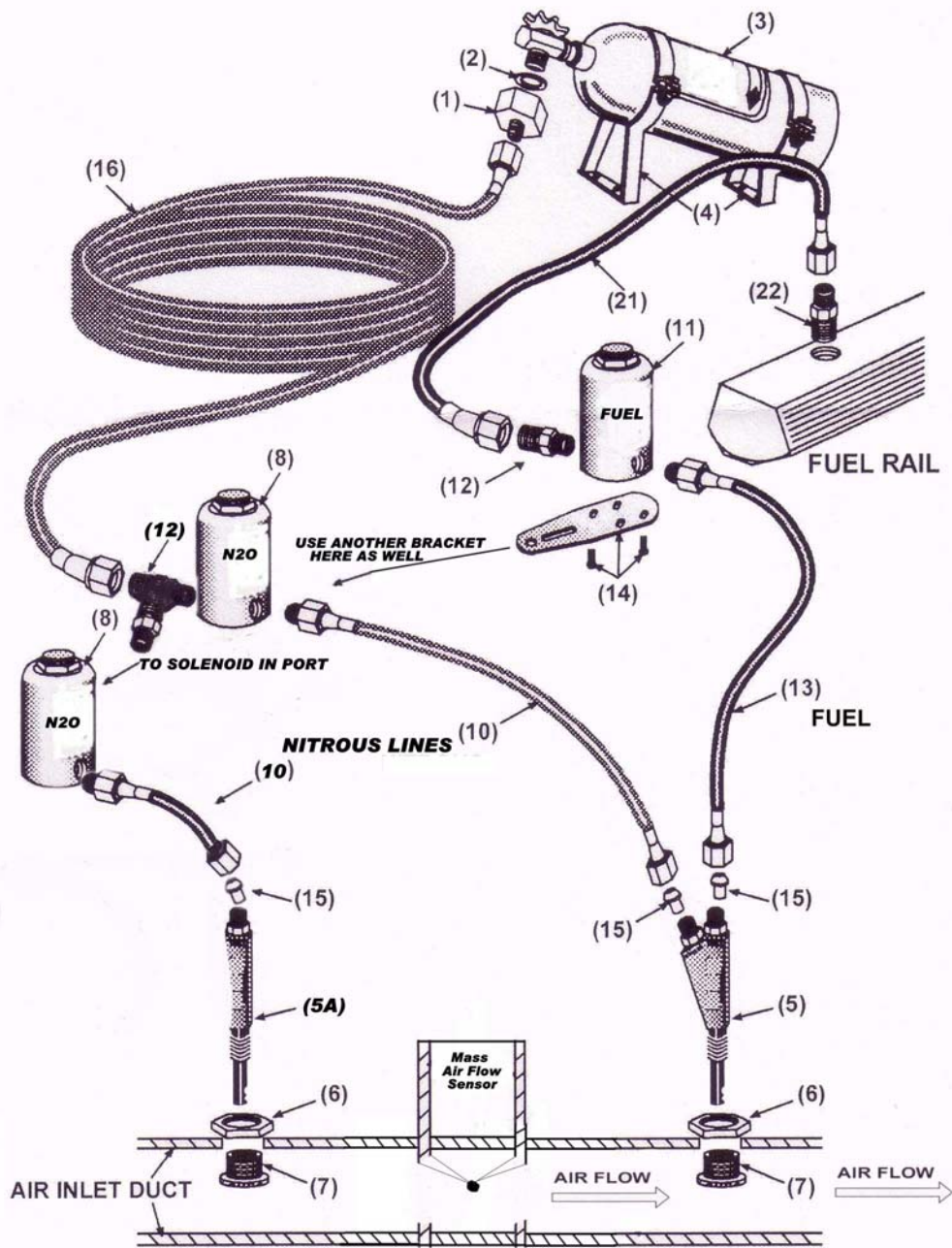

FIG. 4

2.4 Wet/Dry nozzle installation

Note: The recommended mounting location for the Wet nozzle (5) is in the air inlet duct, between the throttle body and Your Factory mass airflow sensor. In certain applications where the throttle body is an integrate part of the air cleaner housing, install the nozzle between the throttle body and the intake manifold. If possible, install the nozzle between 6 and 12 inches before the throttle body or any major turn in the air inlet duct. See figure 5. Mount the Dry Nozzle (5A) In Front of the mass airflow sensor so that the nitrous will blow onto the hot wire element in the sensor! Its best to try and mount the dry nozzle a foot away from the sensor otherwise the nitrous might blow right pass the sensor and the additional fuel your injectors should add might not be there. Even mounting in the air cleaner lid is fine. The engine airflow will pull the nitrous fog right by the sensor so this is the best mounting location.

- 1) Before making any permanent modifications to the vehicle, layout the location of all major components (solenoids, nozzles, fuel/nitrous supply lines etc.)
- 2) Select the desired mounting location for the nozzles, taking into account the length of the nitrous and fuel supply hoses and the intended location of the solenoids. Take into account that the nozzle and lines must clear the hood so check for clearance before drilling.
- 3) Remove the air inlet duct.
- 4) Drill a hole into the centerline of the inlet duct and use the nozzle mounting nuts and screws. This will prevent the nozzle from blowing out while using the nitrous. It's only needed if mounting in plastic or rubber. Secure nuts on with RTV silicone.. Note: Make sure and remove all chips and debris from the air inlet. Caution: Make sure the nozzle is fully secured to the inlet tube if the nozzle pops out under use it may cause a hazardous condition. If mounting in metal, use a 1/16" NPT tap (1/4" hole) to make the threads for the nozzles.
- 5) Make sure the discharge side of the nozzle is pointing toward the engine. Reinstall the air inlet duct.

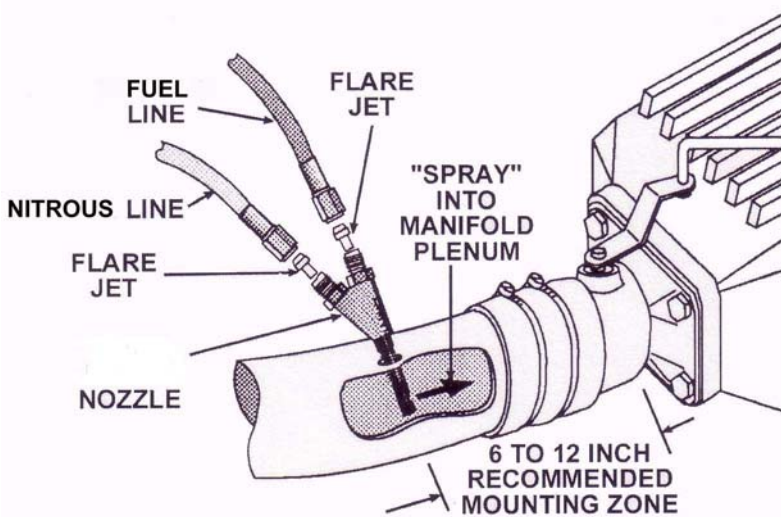

FIG. 5

2.5 Solenoid Mounting

Caution: do not over tighten the vise in the following procedure, or the solenoids will be damaged.

- 1) Clamp the nitrous solenoid (8) in a bench vise.
- 2) Thread the 4AN X 1/8" NPT X 1/8" NPT fitting (12) into the inlet ports of the nitrous solenoids (The Nitrous solenoids have Blue or Black power wires).
- 3) Thread the 1/8" NPT male end of the blue 2 ft 3AN hoses (10) into the outlet ports of the nitrous solenoids. Remove from the vise.
- 4) Clamp the fuel solenoid into the vise.
- 5) (Fuel solenoids have red power wires).
- 6) Thread the 1/8" NPT male end of the red 2 ft. 3AN hose (21) into the outlet port of the fuel solenoid. Use Teflon paste to avoid leaks!
- 7) Attach the nitrous solenoids to the mounting brackets (14).
- 8) Attach the fuel solenoid to the mounting bracket (14). Note: Only one bracket used.
- 9) Select the mounting location for the solenoid assemblies ensuring the assembly will not interfere with engine accessories or throttle actuation. Make sure the hoses do not get kinked. Keep away from Heat and Exhaust.
- 10) Mount the solenoid assemblies

2.6 Solenoid / nozzle hose connection

- 1) Select the proper nitrous and fuel jets (15). Place the desired jets into the nozzles, making sure that the jets are inserted into the correct locations, as marked in figure 5 Check the jet cart for correct jet sizes.
- 2) Connect and tighten the blue fitting side of the 2 ft. 3AN hose (10) to the wet nozzle, see figure 5
- 3) Connect and tighten the red fitting side of the 2 ft. 3AN hose (10) to the wet nozzle, see figure 5
- 4) Connect and tighten the blue fitting side of the 2 ft. 3AN hose (10) to the dry nozzle, see figure 5

2.7 Nitrous Feed Line Mounting

Hint, most late model vehicles have access plugs in the trunk floor, which are convenient for nitrous line routing. Following the fuel lines along the underbody, and entering the engine bay through the front fender well between the plastic inner fender panel and the body, is the most common method of routing the line.

- 1) Determine the route for your nitrous feed line. Ensure the path is clear of the exhaust and moving parts like wheels, brakes, steering linkage etc.
- 2) Feed the nitrous supply line (16) along the route you have decided on.
- 3) Use nylon quick zips to secure the Line as needed.
- 4) Attach the Nitrous Feed line to the 4AN bottle nut (1) on the nitrous bottle. **Warning: Nitrous oxide can cause death if inhaled or cause severe frost bite if it contacts your skin, always point the line away for people or objects when purging the air from the line.**
- 5) Purge the nitrous supply line at the solenoid end.
 - a. Wrap the nitrous line open end with a rag and secure down.
 - b. Crack the bottle valve slightly to purge the line, it only takes a second to purge the line.
- 6) Attach the nitrous supply line to the solenoid fitting on the inlet port, again the nitrous solenoid has blue or black power wires.

2.8 Fuel Supply Connection

The fuel supply can be achieved by connecting into any component of the original equipment high-pressure fuel supply system. Some examples are as follows:

- Connecting to the fuel pressure test port installed in the fuel rail (if available)
- Connecting to the fuel rail by tapping into the end of the caps on the fuel rail
- Connecting to the banjo fitting on the fuel filter (European cars)
- Connecting to the fuel supply hose of the original fuel system

2.8.1 Fuel Supply Connection by using Fuel Rail Test Port

Supplemental fuel to the DynoTune nitrous oxide injection system is taken directly from the fuel rail, which feeds the engine's fuel injectors. Figure 6 shows the typical fuel rail configurations. If you cannot locate the fuel rail on your engine, consult a repair manual for your vehicle.

- 1) Identify the location of the fuel rail "test port" on the fuel rail.
- 2) Remove the protective cap from the test port. Remove the Schrader valve from the test port using a tire valve core removal tool.

CAUTION! When removing the Schrader valve from the fuel rail test port, use caution. Fuel in the rail is under high pressure. Never remove the Schrader valve when the engine is hot or running.

- 3) Connect the fuel supply line (21) to the fuel rail test port.

NOTE: Some Vehicles equipped with a fuel rail test port do not have threads on the test port compatible with the red 4AN supply line. If your vehicle is so equipped, you must either replace the test port fitting with the 1/16" NPT x 4AN fitting (22), or install the 1/16" x 4AN fitting (22) using steps A through F on the following page.

2.8.2 Fuel Supply Connection by Tapping the fuel Rail

NOTE: If your vehicle's fuel rail is not equipped with a test port, the fuel rail will need to be removed and tapped for the 1/16" NPT x 4AN fitting (22) using the steps A through F on the following page.

CAUTION! Before attempting any modification to the fuel rail, make sure that enough wall thickness is available to achieve 3 to 4 threads of engagement during the tapping operation. This would be equivalent to .120" (3.00mm) to .150" (4.00mm) wall thickness.

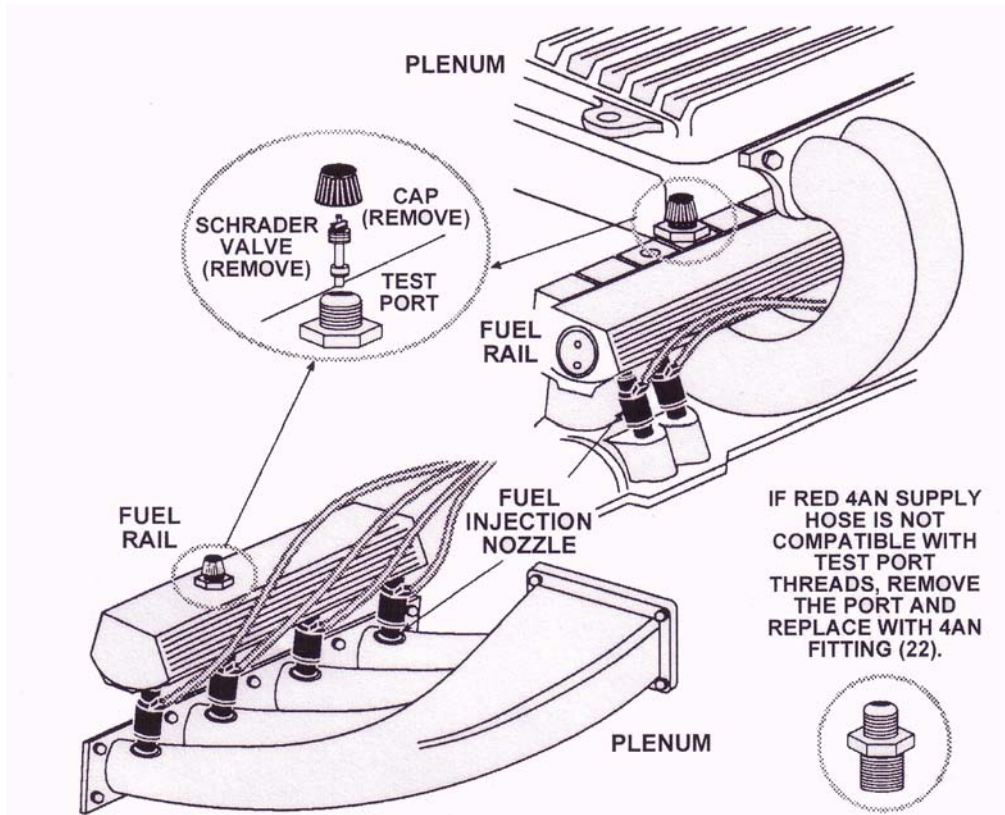

FIG. 6

- A. Select a location for the 1/16" NPT x 4AN fitting (22) on the fuel rail. Make sure that the fitting and line are clear of all engine components.
- B. Remove the fuel rail from the engine. Remove the fuel injectors and regulator (if applicable) from the fuel rail. Drill a 1/4" hole in the fuel rail, making sure that the hole is perpendicular to the mounting surface, and that the hole penetrates into the fuel rail reservoir.
- C. Tap the 1/4" hole with the 1/16" tap (25). De-Burr entry and exit holes.
CAUTION! Remove all debris in the fuel rail or engine damage could occur.
- D. Install the 1/16" NPT x 4AN fitting (22) in the tapped hole. Use Teflon paste to avoid fuel leaks.
- E. Clean debris out of the fuel rail once again just to be safe.
- F. Re-install the fuel rail injectors and regulator. Use clean engine oil to lubricate the injector o-rings.
- G. Install the fuel rail onto the engine.

4) Thread the remaining end of the 4AN hose (21) to the test port/4AN fitting.

2.8.3 Fuel Supply Connection by Tapping into the main Fuel Supply Fitting

Some engines utilize a fuel rail or distribution block system that does not have test ports and does not allow drilling and tapping to install the 4AN fitting. Supplemental fuel for the DynoTune nitrous oxide injection kit must be acquired from the fuel injectors high-pressure supply line.

- 1) Locate the main fuel supply line. The main supply line feeds pressurized fuel from the fuel pump (in-line or in-tank fuel pump) to the fuel filter and from the fuel filter to the fuel rail or distribution block. The most desired location to "Tap" into the fuel line is after the fuel filter.
- 2) Examine the outlet fuel filter or the inlet to the central distribution block for a "Banjo" bolt fitting. See figure 8. Remove the fitting and examine the diameter of the shank of the fitting. To use this fitting for the supplemental fuel supply, the diameter must be sufficient for a 1/4" hole to be drilled through the centerline of the fitting. See figure 8.
- 3) Drill a 1/14" hole through the centerline of the banjo fitting. (Note: Remove Banjo before drilling)
- 4) Tap the 1/4" hole with the 1/16" NPT tap (25). **CAUTION! All debris MUST be removed from the inlet fitting. Failure to do so can result in severe engine damage.**
- 5) Thread the brass 1/16" NPT to 4AN fitting (22) into the modified banjo fitting. Use Teflon paste to avoid fuel leaks.
- 6) Install the modified banjo fitting into the fuel filter.
- 7) Thread the open end of the red 4AN hose (21) on to the 4AN fitting.

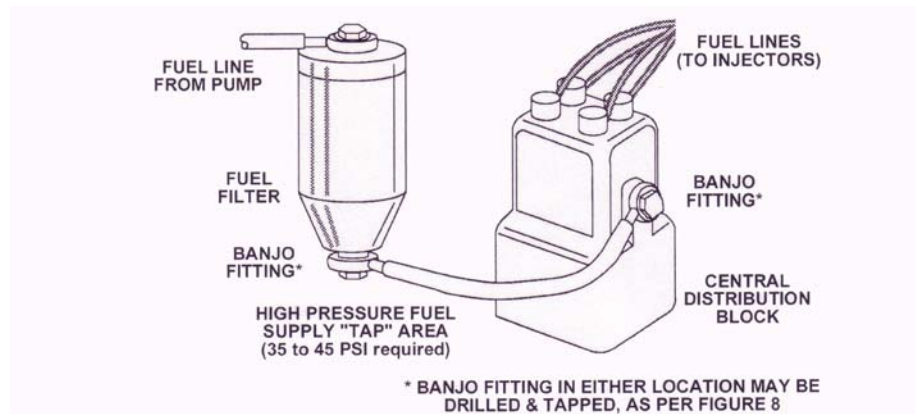

Figure 8 Schematic of "Drilled Out" Banjo Fitting



FIG. 8

2.8.4 Fuel Supply Connection by Tapping into the main Fuel Supply Hose (rubber hose only)

- 1) Locate the main fuel supply line. The main fuel supply line feeds pressurized fuel from the fuel pump (in-line or in-tank fuel pump) to the fuel filter and from the fuel filter to the fuel rail or distribution block. The most desirable location to "Tap" into the fuel line is after the fuel filter.
WARNING! Certain vehicles are equipped with main fuel lines that are hard plastic with a rubber-like shell. DO NOT cut or splice into this type of line, since leak proof connections cannot be achieved with the supplied hardware. Leaking fuel lines may cause engine damage, injury or death.

- 2) Locate a section of the rubber main fuel supply line where the 5/16" hose barb can be easily installed and the fuel enrichment supply line can be easily connected without interfering with the engine and or any moving parts.
- 3) Assemble the 5/16" hose barb fitting (26) to the 5/16" hose barb "T" (23). Use the provided hose clamps and hose to make the necessary connections.
- 4) Use hose clamps (24) on all connections using rubber hose. Connect the end of the rubber hose to the fuel solenoid, use the Hose Barb to 1/8" NPT male fitting and screw this into the solenoid using Teflon paste.

2.9 Electrical System installation

Refer to figure 9 and the procedures in this section for electrical system installation. **WARNING! Death or injury may occur from working on a charged electrical system.**

- 1) Disconnect the battery at the ground cable (if not already done.)
- 2) Install the arming switches in the vehicle interior, within easy reach from the drives seat. This switch will put power to the entire system. Mount the first stage to the left of the second stage-arming switch so you can tell what stage is first. CAUTION! Never activate your nitrous system below 3000 RPMS as doing so could damage your engine.
- 3) Install the relays and the relay harness in the engine compartment near the battery.
- 4) Connect the fuse wires to the battery (+) terminal. Connect the other fuse wire to the Black wires going to the relay. Install the fuses into the fuse holders.
- 5) Finish the wiring as shown in the picture making sure not to confuse the two stages. Install one at a time as they are independent from each other. **(NOTE: Blue wires on the relays are not used)**
- 6) Install the TPS/Window switch in an easy to access location. You can mount it in the engine compartment if you want. **KEEP ALL WIRES AWAY FROM IGNITION WIRES!!!!**
- 7) We will cover programming the TPS/Window switch a bit latter.

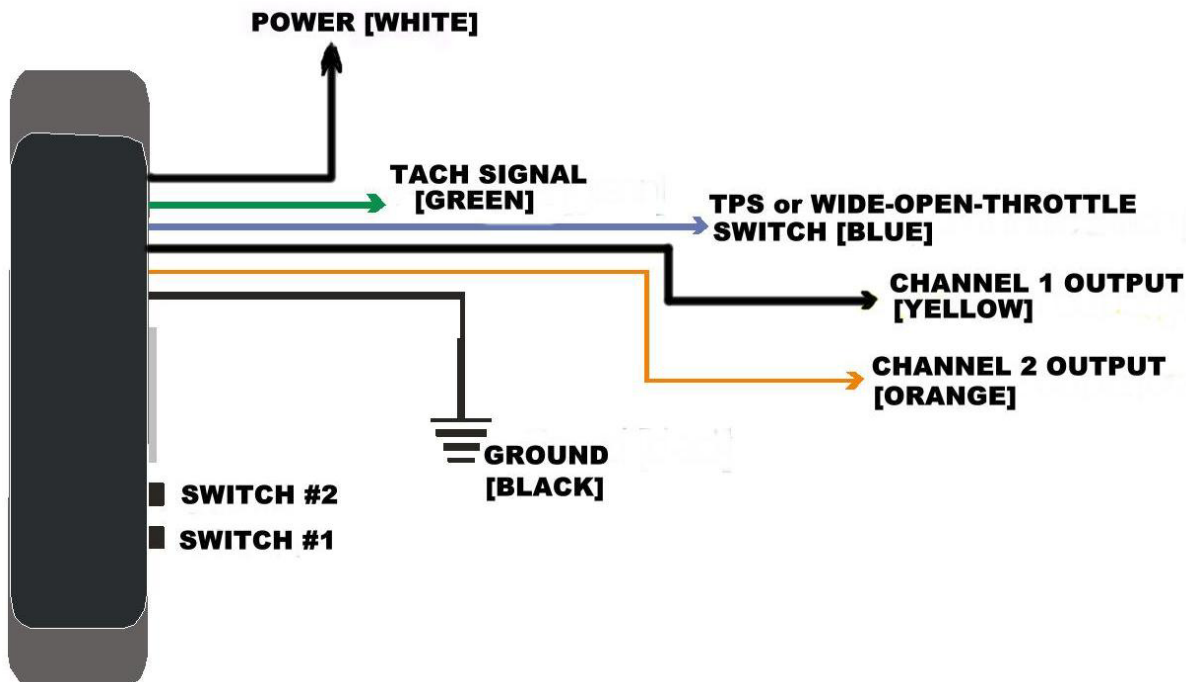

First Stage Dry Wiring Diagram

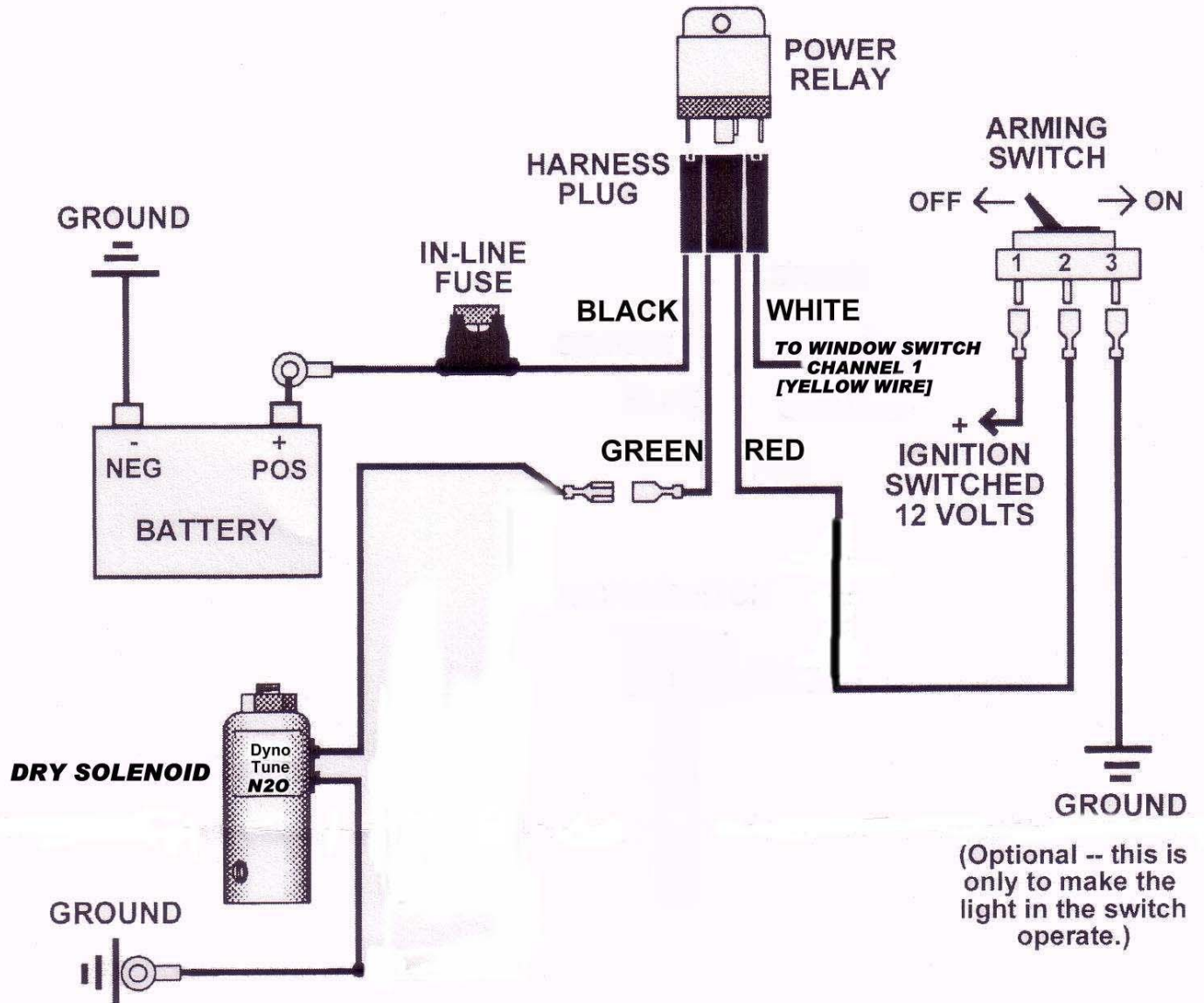

Second Stage Wet Wiring Diagram

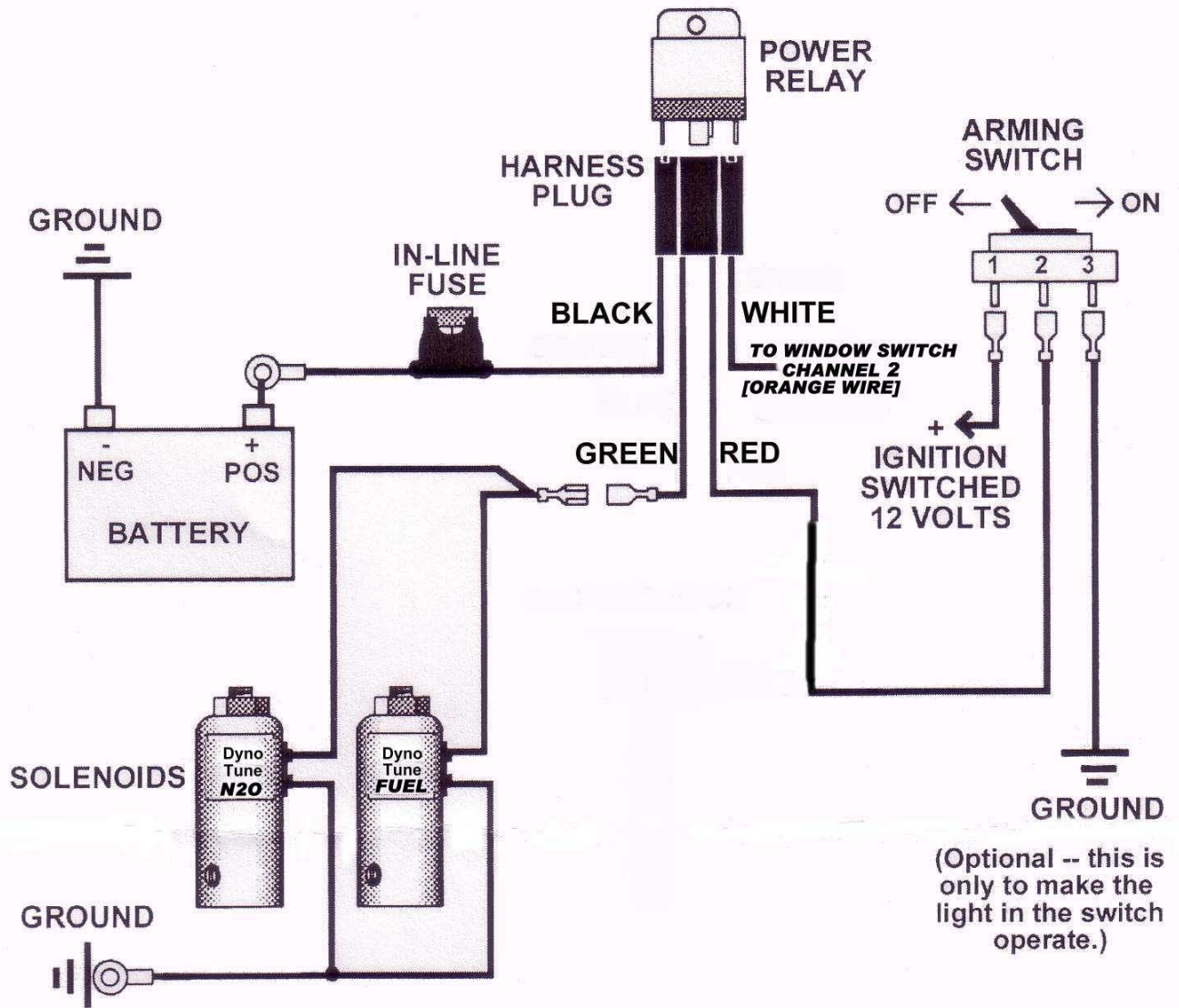

1) Reconnect the battery.

DYNOTUNE TPS - RPM WINDOW SWITCH INSTALLATION

Operation

The Dynotune RPM WINDOW SWITCH is a 2 channel RPM activated window switch (RPMWS) with an integrated throttle-position activation switch (TPAS). The unit accepts most tach signals, including low-voltage and irregular signals such as those found on many V-10s. The TPAS accepts all analog throttle-position sensor signals as well as a “hot” or “grounded” wide-open-throttle (WOT) switch.

Both channels have their own settable ON and OFF points. Each channel also has its own multi-gear lockout feature, which allows it to be turned off until you have cycled through the window. The internal TPAS can be configured to prevent the RPMWS channels from activating unless you are at WOT.

The Dynotune RPM WINDOW SWITCH requires 9~18 volts to operate correctly. **The output lines SWITCH GROUND when activated (ON) and have a maximum current rating of 1 amp.**

DO NOT CONNECT SOLENOIDS DIRECTLY TO THE OUTPUT WIRES!!! RELAYS MUST BE USED !!

In run mode, the LEDs (A,B,C.)will show the unit's status.

- A = throttle position activation switch status [0 = OFF / 1 = ON]
- B = gear lock out for channel 1 [0 = feature OFF / L = locked out]
- C = gear lock out for channel 2 [0 = feature OFF / L = locked out]

Press and hold switch #1 and the unit will display the current RPM. This will be very useful to verify your setting in STEP 1 of the configuration. *Example: r 3 1 = 3100 RPM*

Programming the TPS - RPM Window Switch

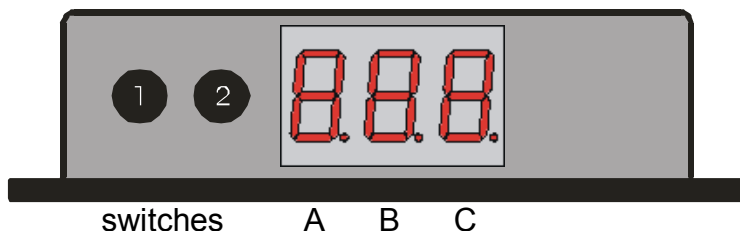

Switch #1 - toggles through the configuration menu. As you toggle through the configuration menu, the stored value will be displayed.

Switch #2 - increments the flashing value that was selected by switch #1.

LED A.B C displays the configuration step number and it's setting

A = configuration item

B C = value for the current configuration step

To enter the programming mode, press and hold both switches until “Pro” is displayed. Now release the switches and the unit will automatically go to the first configuration step.

STEP 1. TACH set-up

B C is the number of cylinders. This setting is used by the RPMWS to calculate the correct RPM.

0 0 = individual coil per cylinder systems where the tach wire is connected to the coil

0 1 = coil packs that fire in pairs (waste spark systems) and the tach wire is connected to the coil

0 2 ~ 1 2 = cylinder combinations from 2 to 12 where the tach wire is connected to the tach from the engine electronic controller or distributor

STEP 2. Gear Lockout

B = how many times you must pass the deactivation set point before channel 1 will activate. 0 turns this option off.

C = how many times you must pass the deactivation set point before channel 2 will activate. 0 turns this option off.

STEP 3. Channel 1 Activation RPM (DRY 1st STAGE)

B C = RPM where 30 = 3000 RPM

STEP 4. Channel 1 Deactivation RPM (DRY 1st STAGE)

B C = RPM where 61 = 6100 RPM

STEP 5. Channel 2 Activation RPM (WET 2nd STAGE)

B C = RPM where 35 = 3500 RPM

STEP 6. Channel 2 Deactivation RPM (WET 2nd STAGE)

B C = RPM where 62 = 6200 RPM

STEP 7. TPAS Mode

B C = throttle position activation switch mode

0 0 = "grounded" WOT switch

0 1 = "hot" WOT switch

0 2 = TPS signal (use this mode)

0 3 = turns this feature off if you are not connecting the blue wire

STEP 8. TPS WOT setting

Note: only applies if Step 7 is configured as 02

B.C = WOT voltage

While at IDLE, Nitrous arming switch off, press switch #2 to read and display the TPS signal. Pop the throttle to open it all the way – the unit only needs to see WOT for a fraction of a second. Now press switch #1 to save the displayed value.

(You do not have to be at WOT when you press switch #1 to save)

You will see **End** when the programming is complete. If at any point you see **Err**, the unit has had an internal malfunction. Turn the power off and back on and try again.

DO NOT CONNECT SOLENOIDS DIRECTLY TO THE OUTPUT WIRES!!!
RELAYS MUST BE USED IF CURRENT DRAW IS MORE THAN 1AMP!!

- 2) Always test each stage one at a time when you are ready to run the system. Start with the 1st dry stage only! **NOTE: Nitrous and Fuel flowing through the solenoids is needed to keep the coils from melting. Short, one second power cycles will not hurt them but more than 5 seconds with no nitrous or fuel flowing through them will melt the coils and void your warranty.**

Chapter 3 Baseline tuning suggestions

Your DynoTune system comes preset with nitrous and fuel jetting based upon engine displacement. The jetting combinations are conservative and are intended to work with stock ignition systems and +92 octane unleaded gasoline. Race gas may be needed if serious power levels are used. Nitrous and fuel jetting combinations are derived based upon 950 PSI (85 degrees F) nitrous bottle pressure and 40 PSI fuel pressure as depicted in table 3. Using the listed jetting and suggested fuel and nitrous pressure levels should yield safe reliable power increases. This tuning chart is only for the wet stage 2. Do not run more than a 50% increase in power without professional tuning and upgraded performance modifications to the drive train and engine. The first dry stage is tuned by simply changing the jets if you want more power. Make sure your fuel system and injectors are up to the task before increasing power.

Table 3 Wet Stage System Jetting Map Guideline

N2O Jet	Fuel Jet at your system PSI				
	20psi	30psi	40psi	50psi	60psi
42	28	26	24	22	22
48	32	30	28	26	24
57	38	36	32	32	30

Using these jetting combinations with lower bottle pressure and or higher fuel pressure may produce an excessively rich condition while using the system. This can result in a loss of power, excessive exhaust smoke (black) or misfiring (backfiring through the exhaust). If you experience any of these conditions, or you desire to maximize the power output from your system, you should refer to Tuning shop.

Caution! Use of excessive bottle pressure and or inadequate fuel pressure can result in an excessively lean condition. In extreme cases, this will produce major engine damage!

Chapter 4 Preparing for operation

Attach your battery.

- 1) Now that your system is ready to run, start with the dry stage. Open the bottle, check for leaks, Start your engine. Make sure you do all your testing at the racetrack only!
- 2) Turn on the arming switch for the first dry stage. Test it out.
- 3) Turn off the first and turn on the second stage. Test it out.
- 4) It should pull nice and steady, any surging or detonation noises you need to stop and fix the problem.
- 5) Once both stages have been tested independently then you're ready to try both stages! Enjoy the power and respect you new found power.

Note: If jets for higher HP gains are being considered, care must be taken to ensure that the fuel delivery system of your vehicle is adequate to support the extra power.. A Fuel pressure safety switch or Air/Fuel ratio switch is recommended to reduce the risk of engine damage should the fuel pressure drop to dangerous levels.

CAUTION! Never activate your nitrous system below 3000 RPM.

Chapter 5 Advanced Tuning for Maximum power (Second stage wet)

5.1 Determining optimum Nitrous/Fuel jetting

The factory calibrated nitrous/fuel ratio included is provided to you with a safe starting point. Baseline Jetting is calibrated using a 950psi nitrous bottle pressure and fuel pressure as stated in table 3. In some instances, slight changes in fuel pressure may produce performance gains.

- 1) Stabilize the nitrous bottle pressure at 950 psi.
- 2) Perform a dynamometer pull or a full throttle pass down the racetrack. Note the power reading or vehicle MPH (not ET). Examine the spark plugs for the indication of lean or rich nitrous/fuel conditions (refer to Figure 11 for tips on reading the spark plugs).
 - A. If the spark plugs appear to be excessively rich, decrease the fuel jet size 2 steps (ex. 26 to 24, 24 to 22, etc)
 - B. A. If the spark plugs appear to be excessively lean, increase the fuel jet size 2 steps (ex. 24 to 26, 22 to 24, etc)
 - C. If the spark plugs have a “like new” appearance on the porcelain and electrode, do not make a fuel jetting change.
- 3) Repeat steps 1 and 2 until the desired mixture is obtained

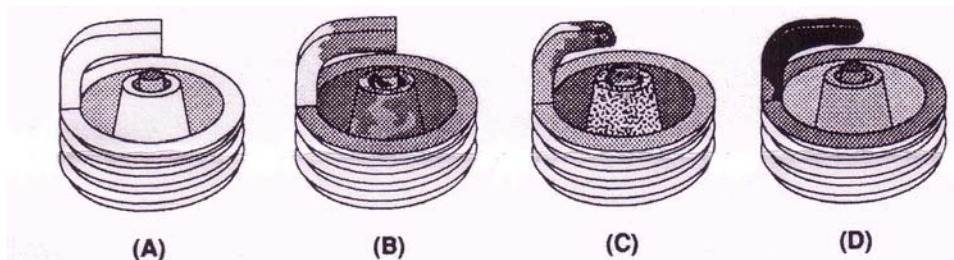

FIG. 11

How to read Spark plugs from a nitrous oxide injected Engine

A. Correct Timing, Mixture and spark plug heat range

Ground strap retains a “like new” appearance. Edges are crisp, with no signs of discoloration. Porcelain retains clear white appearance with no “peppering” or spotting.

B. Excessively Rich Mixture

Porcelain may be fuel stained appearing brown or black. In extreme cases, the ground strap, electrode, and porcelain may be damp with gasoline, or smell of fuel.

C. Detonation

Edges of the ground strap may become rounded. Porcelain has the appearance of being sprinkled with pepper, or may have aluminum speckles. During heavy detonation, the ground strap tip may be burnt off. This phenomena can result from excessive ignition timing, too high a heat range spark plug, or inadequate fuel octane.

D. Excessively Lean Mixture

Edges of the ground strap may become rounded. Under moderate overheating, the tip of the ground strap can discolor, usually turning purple in color, or the entire ground start can become discolored.

NOTE: For 125HP-150HP increases in power you should use one heat range cooler spark plugs
NOTE: Never use platinum tip spark plugs.

077707

5.2 Determining Optimum Ignition Timing

IMPORTANT! Ignition timing should be retarded approximately 2 degrees per 50 hp increase due to nitrous oxide injection. Start with the engines best total timing and reduce from there. Use the initial settings, which are 2-3 degrees more retarded than you expect to be optimum.

EXAMPLE: Total ignition timing with nitrous-----38 Degrees
100HP increase from nitrous---2 Degrees/50HP----4 Degrees retard
Initial Safety margin-----2 Degrees retard
Initial Timing with Nitrous-----32 Degrees

The following scheme for determining ignition timing should allow you to determine the optimum setting for you vehicle, without incurring engine damage during the tuning phase.

1. Estimate the reduced ignition timing that you think will produce the best power, based upon the 2-Degree retard per 50HP increase rule.
2. Set the ignition timing 2 to 3 degrees retarded from your best power estimate setting.
3. Stabilize the nitrous bottle pressure at 950PSI.
4. Perform a dynamometer pull or a full throttle pass down the racetrack. Note the power reading or vehicle MPH at the track.
5. Increase the ignition timing 2 degrees.
6. Perform a dynamometer pull or a full throttle pass down the racetrack. Note the power reading or vehicle MPH at the track. Examine the spark plugs for signs of detonation (refer to figure 11 for tips on reading spark plugs).
 - A. If power increase or vehicle MPH increase **AND** spark plugs show no signs of overheating or detonation, increase the ignition 2 degrees.
 - B. If power increase or vehicle MPH increase **AND** spark plugs begin to show slight signs or detonation-**STOP**. Do not advance the timing further. You may choose to reduce the timing 2 degrees at this point for an extra margin of safety.
 - C. If power decreases or vehicle MPH decreases, reduce the ignition timing 2 degrees.
7. Repeat step 6 until optimum ignition timing is obtained.
8. NOTE: No Timing retard should be needed for the Dry stage if 100hp or less is used total.

Chapter 6 Routine Maintenance

6.1 Nitrous filters and lines

- 1) Clean the Filter in the nitrous solenoid inlet port if so equipped.
- 2) Inspect all fuel lines and nitrous lines for leaks and repair as needed.

6.2 Nitrous Solenoid Plunger

6.2.1 General information

The seals used in DynoTune nitrous oxide solenoids are designed to be used with nitrous oxide only. When kept from fuel contamination or over pressurization, they should provide trouble free performance. You should periodically (after every 20-30 pounds of nitrous usage) examine the seal in the Nitrous solenoid plunger. The seals used in the plungers are designed to work at pressures up to 1100psi. Exposing the plunger to excessive pressure can result in the seal in the plunger swelling or in extreme cases, the plunger seal disintegration resulting in a leaky solenoid.

NOTE: The swelling of the nitrous solenoid plunger seal will reduce nitrous flow (causing an excessively rich nitrous/Fuel condition and a loss of power).

Note: Fuel solenoids should not be used with Alcohol or methanol based fuels as the plunger will swell.

6.2.2 Solenoid plunger Disassembly and inspection

- 1) Close the valve on the nitrous bottle.
- 2) Empty the main nitrous supply line.
- 3) Remove the supply line.
- 4) Remove the retaining nut from the solenoid and remove the coil and housing. Note any shims.
- 5) Unscrew the stem from the solenoid base. Do this by double nutting the stem; do not use pliers as this will damage the stem!
- 6) Remove the stem, spring and plunger from the solenoid base.
- 7) Examine the plunger seat for swelling. The seal surface should be flat, except for a small circular indentation in the center of the seal.
A fuel-contaminated seal will protrude from the plunger and be dome-shaped. A fuel-contaminated seal may return to its original shape if left in the fresh air over several days. A seal, which is flat, but protrudes from the plunger body has probably failed internally and should be replaced.
- 8) Re-assemble in reverse order.

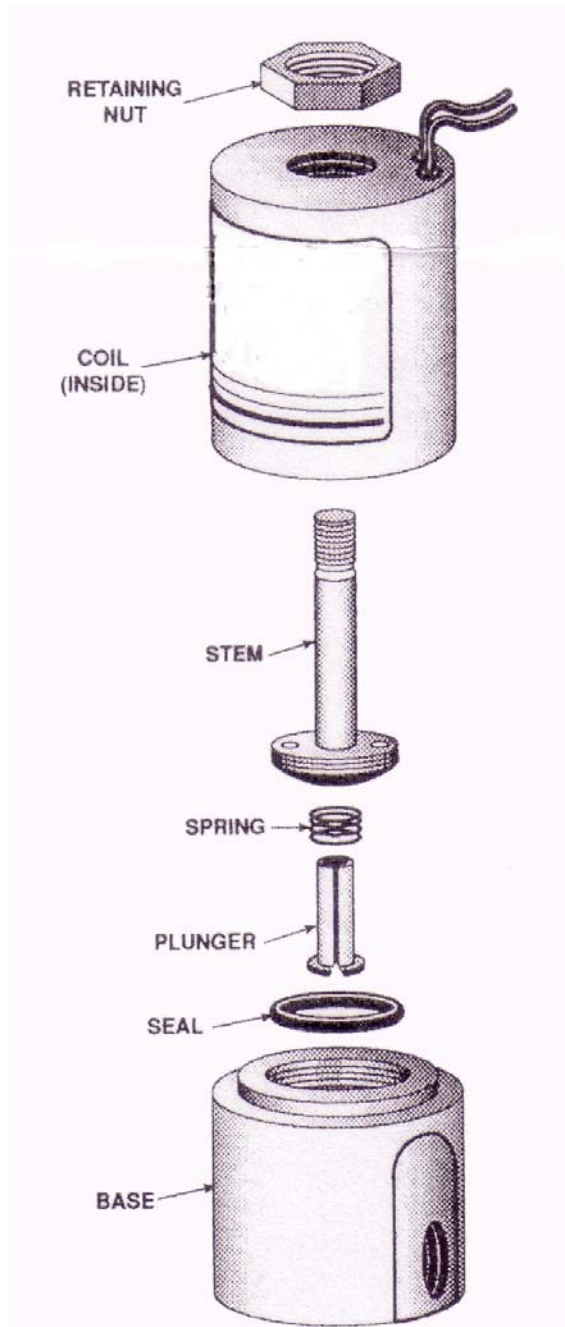

FIG. 12

Troubleshooting Chart

PROBLEM	POSSIBLE CAUSES	DIAGNOSTIC PROCEDURE	CORRECTIVE ACTION
No change in engine speed when the fuel solenoid is activated (preparing for operation -- chapter 4)	System wired incorrectly	Compare wiring to Wiring fig 9.	Wire per instructions.
	Restricted fuel flow.	Inspect fuel filter or restrictions (crimped or plugged).	Remove restriction
	Malfunctioning fuel solenoid.	Turn armring switch on. Cycle the motor switch. Solenoid should make a "clicking" noise.	repair / replace solenoid
Change in engine speed when nitrous bottle valve is opened-preparing for operation chapter 4	Malfunctioning nitrous solenoid	Remove and inspect solenoid	repair / replace solenoid
Engine enrich when system is activated	Bottle valve not fully opened	Check bottle valve	Open valve Fully
	Bottle mounted improperly	Check bottle orientation	mount bottle properly
	Plugged nitrous filter	Inspect filter	Clean/ Replace filter
	Low bottle pressure	Check bottle temp/ pressure	Set bottle temp to 75-85 For 950 PSI pressure
	Inadequate nitrous supply	Weigh bottle	Fill bottle
	Mismatched nitrous fuel jets	compare jets to recommended jets	install correct jets
	Excessive fuel pressure	Install a fuel pressure gauge, measure pressure during acceleration with system activated	Regulate pressure down or install smaller fueljet
	Loose nitrous solenoid wiring	Inspect nitrous solenoid wiring	Repair wiring.
	Malfunctioning nitrous solenoid	Observe the bottle valve. Disconnect the nitrous solenoid (+) lead. Open the nitrous bottle valve. Connect +12v to the solenoid lead. Nitrous should discharge at high rate.	Rebuild solenoid
No change in performance when system is activated.	System wired incorrectly	Compare wiring to schematic in figure 9	Wire system per instructions
	Loose ground wire(s)	terminal Check for continuity at grounds noted in figure 9	Tighten/ Repair loose grounds
	Malfunctioning armring switch	tight to battery (-) terminal Check for power at pole #2	Replace pushbutton
	No power to armring switch	Connect 12v test light to battery (-) terminal Check for power at pole #1 on armring switch.	Repair wiring.
	Malfunctioning TPS/ WINDOW SWITCH	READ Manual for TPS/ RPM window switch	Replace TPS/ WINDOW SWITCH
	Overly rich fuel condition	Check for black smoke or backfiring through the exhaust with system activated.	Install smaller fueljet or decrease fuel pressure
	Engine detonates mildly when system is activated	Excessive ignition timing	Check ignition timing
Inadequate octane fuel			Use higher octane fuel
Spark plug heat range too high.			Reduce spark plug heat range (maximum 2 steps)
Too much nitrous flow		Check bottle pressure as it may be too high	Reduce nitrous jetting

Troubleshooting Chart Continued

PROBLEM	POSSIBLE CAUSES	DIAGNOSTIC PROCEDURE	CORRECTIVE ACTION
Engine detonates heavily when system is activated	Inadequate fuel delivery due to: Plugged fuel filter	Inspect filter	Clean or replace filter
	Crimped fuel line	Inspect fuel line	Replace crimped line
	Weak fuel pump	Replace fuel pump with high performance version	Repair/Replace fuel pump
High-RPM misfire when system is activated.	Excessive spark plug gap	Inspect spark plugs	Set spark plug gap at .030" to .035"
	Weak Ignition/Ignition component failure	Inspect components (Plug wires, distributor cap, etc.)	Replace worn parts.
Surges under acceleration when system is activated.	Inadequate supply of nitrous	Check bottle weight	Fill bottle
	Bottle mounted incorrectly	orientation to instructions (figures 2&3)	Mount Bottle in correct orientation